



THE BASIC
GUIDE TO
MAT
DECORATION

By Vivian C. Kistler



Includes
How To Make
Memory Books!

MAT DECORATION

The Basic Guide to Mat Decoration
by Vivian Kistler, CPF, GCF

© 2006, 2001 Logan Graphic Products, Inc.,
Wauconda, Illinois
All rights reserved
First Edition in 8.5x11 format
Printed in the United States of America
Columba Publishing Company, Akron, Ohio

10 9 8 7 6 5

ISBN 0-938655-72-8

Translation or reproduction of any part of this work, beyond that permitted by the International Copyright Act, without the permission of the copyright owner, is unlawful. Please request permission or further information from the Permissions Department, Columba Publishing Co. Inc. 154 Pembroke Rd, Akron OH, 44333 USA
Telephone: 1.330.836.2619
Fax: 1.330.836.9659
www.columbapublishing.com

The information and suggestions in this book are offered in good faith, but without guarantee, since the techniques of individuals are beyond our control. We recommend the user determine, for her/his own purposes, the suitability of all materials and suggestions mentioned. Logan Graphic Products, Columba Publishing and Vivian Kistler, both individually and combined, disclaim all responsibility for loss or damage resulting from the use of the information furnished herein.

CONTENTS

Mat Decoration	5	Rub-on Designs & Monograms	34
Basic Principals of Designing Mats	6	Stencil Decoration	37
		Designs for Stencils	38
The Basic Mats		Ink Lines	39
The Single Mat	8	Ruling Pens	39
The Double Mat	10	Ruling Pen Technique	40
Making a Guide for Decorative Borders	12	Mat Decoration	41
		Correcting Overruns	43
Tips and Techniques	14	Color Panels	44
		Using Watercolors	44
		Using Chalk Pastels	47
DECORATIVE SURFACE CUTS		Decorating with Rubber Stamps	51
Matboards	15	Decorative Items	52
Tools for Surface Cuts	16	Woven Ribbon Mat	53
Hand Knife Technique & Design Ideas	17	Threaded Borders Mat	55
Cutting V-Grooves		Quick Shadow Box	56
Using a <i>Simplex V-Groover</i>	18	Memory Book	57
Offset Corner	20	Fabric-Covered Mats	
Inside Angle	21	Wet Mounting Method	59
Connecting Angle	23	Cold Mounting Method	60
Cut-away Designs	25	Wrapping a Bevel on Fabric-Covered Boards	62
Designs for Cut-aways	27		
Linear Cut Designs	29		
DESIGN ELEMENTS			
Decorating Bevels	30		
Painted/Colored Bevels	30		
Paper Fillets	33		

Guide to the Mats on the Front and Back Covers

Directions for the mats pictured on the front and back covers are to be found in this book. Use the guide below to find your favorite style.

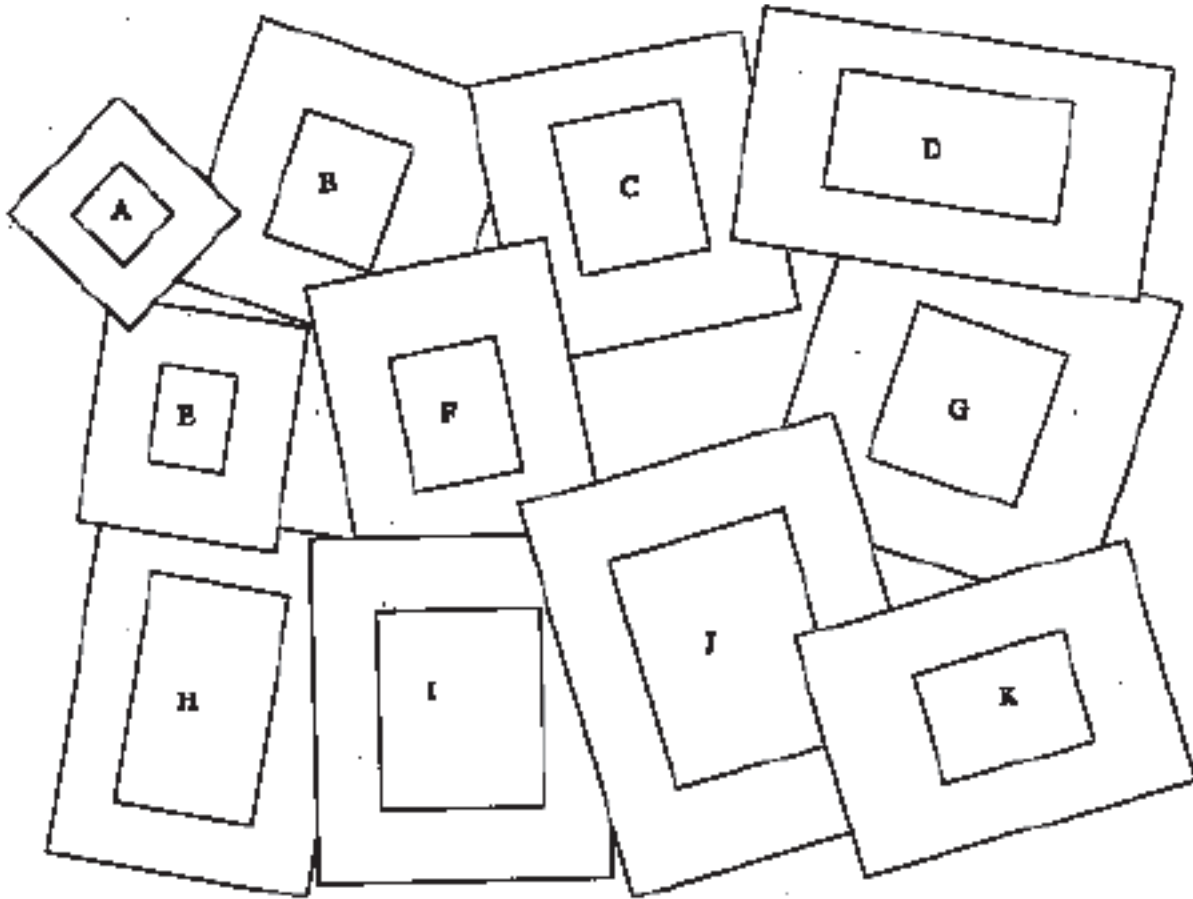

- A. Woven Ribbon Mat, pg. 53
- B. Double Mat, pg. 10
- C. Painted Bevel, pg. 30
- D. Inside Angle V-Groove, pg. 21
- E. Rub-Ons, pg. 34-36
- F. Fabric-Covered Mat, pg. 59-62

- G. Stenciled Mat, Pg. 37
- H. Ink Lines, pg. 41
- I. Color panel, pg. 44
- J. V-Groove, pg. 18
- K. Memory Book, pg. 57

Art shown on the cover

- Reproductions used in matting B, C, D, H, J are courtesy of Wild Apple Graphics, Woodstock, Vermont.
- A, E, F, G, I, K are from the private collection of the author.

MAT DECORATION

Mats may be used on any art on paper, fabric art or needlework. Mat cuts and decorative techniques can enhance the display of all sorts of artwork, such as family documents, photographs, and anything from paintings to needlework.

This book contains a wide variety of techniques using inks, watercolors, acrylic paints, pastels, tapes, rub-on designs, art papers, ribbons, and rubber stamps to decorate matboards. There are also several mat cuts shown in this book which may be used to embellish the mats.

Mats may be purchased in standard sizes in a wide variety of openings and colors. Or they can be cut using any of the mat cutters detailed on the last two pages of this book.

Designs can be subtle and unobtrusive, or very decorative works of art in themselves.

Use the guide on the facing page to locate mats pictured on the front and back covers.

Follow the directions on pages 12 and 13 to make a handy guide for placement of lines on decorative borders.

For Basic Mat Cutting information:

A companion book: *The Complete Guide to Basic Mat Cutting* contains information on color selection, proportion, standard sizes, measuring for mats, cutting singles, doubles, inlays and offsets. Also included are several oval and circle cuts as well as multiple opening mats.

THE BASIC PRINCIPLES

SIZE

The border should be even on all four sides, unless a weighted bottom is being used, in which case the bottom of the mat is slightly larger than the borders of the sides and top.

Do not be afraid to use a wide mat. The purpose of the mat is presentation. It can provide the decorative element to coordinate the art with the environment and it can provide important breathing space between the art and the wall.

For example, wallcovering can interfere with the enjoyment of art because the pattern distracts one's focus from the artwork. A well proportioned mat will provide the space required to enjoy the artwork.

DECORATION

Decorative elements should generally stay within the first third of the mat width from the opening. This provides a comfortable transition from the frame to the mat to the art.

COLOR

Color selection can be based solely on the artwork itself. When looking at the piece, determine which colors represent the largest portion of space and which the least. If used in the same proportions for the mat and frame, a harmony will result. If you use it in opposite amounts, a contrast will be created drawing attention to the entire presentation.

DESIGN

The design can be inspired by the character of the artwork itself or the period design of the room where it will be displayed. Books on interior design will explain the colors used to depict many period designs.

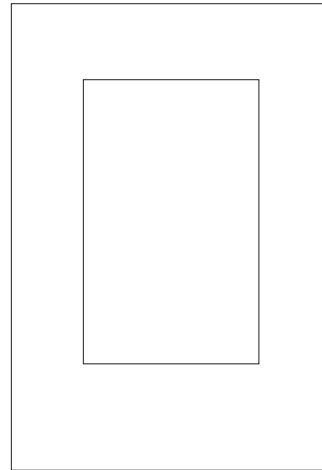

The top and sides are the same width while the bottom is slightly larger.

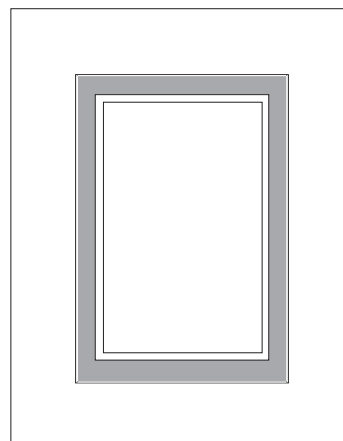

Keep decorative elements within the first third of the border.

OF DESIGNING MATS

Multiple mats require special consideration with regard to shape and proportion, to avoid a distracting over-stripped effect.

When making triple mats, the size of the two liner mats should not be identical.

Example:

**Top mat is 2-3/4"
Middle mat is 3/4"
Liner mat is 1/4"**

or

**Top mat is 2-3/4"
Middle mat is 1/4"
Liner mat is 3/4"**

Whenever possible, do not duplicate the width of a mat, liner, fillet, or frame. The design may look alright, but with better proportions, it could look fantastic.

When placing objects or multiple openings in a mat, gather the elements toward the center while leaving a border around the outside edge to balance the pieces. The outside border should be significantly larger than the inner widths.

Decoration can be concentrated at the bottom, center or top. Plan to divide the available space in approximately thirds; use one third or two thirds for decoration allowing the last third to balance the design.

Oval and circle mat openings look better if they are placed in square or rectangular frames rather than ovals or circles.

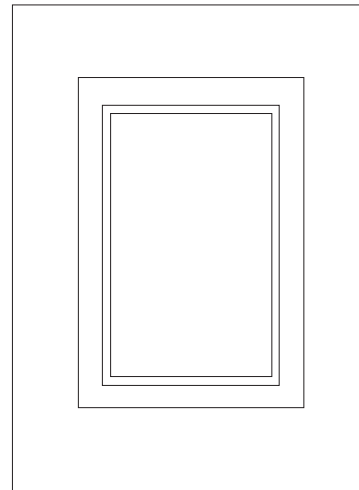

When designing double or triple mats, use different widths to create balance.

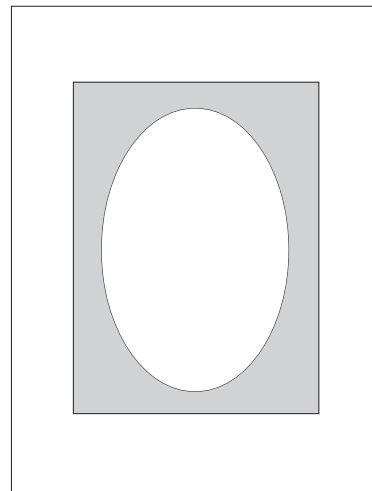

A pleasing balance is created when an oval is used within a rectangle.

THE SINGLE MAT

These directions are for use with a Logan *Compact* mat cutter to make an:

11 x 14" mat
5 x 8" opening
with a 3" border on all sides.

1. Slide a slip sheet onto the base of the cutter. Slip sheets are made from scraps of matboard approximately 6" wide by 20" to 30". A much neater cut will be achieved by using a slip sheet.
2. Set the side mat guide at 3". To set the mat guide: loosen the black knobs, press down on them until they click, then slide the guide into position, and tighten the knobs.
3. Take the trimmed 11 x 14" at board and slide it *face down* under the guide rail and face against the side mat guide.
4. Using a pencil, draw a line against the rail onto the matboard. Repeat this on the other three sides. The lines must be long enough to intersect.

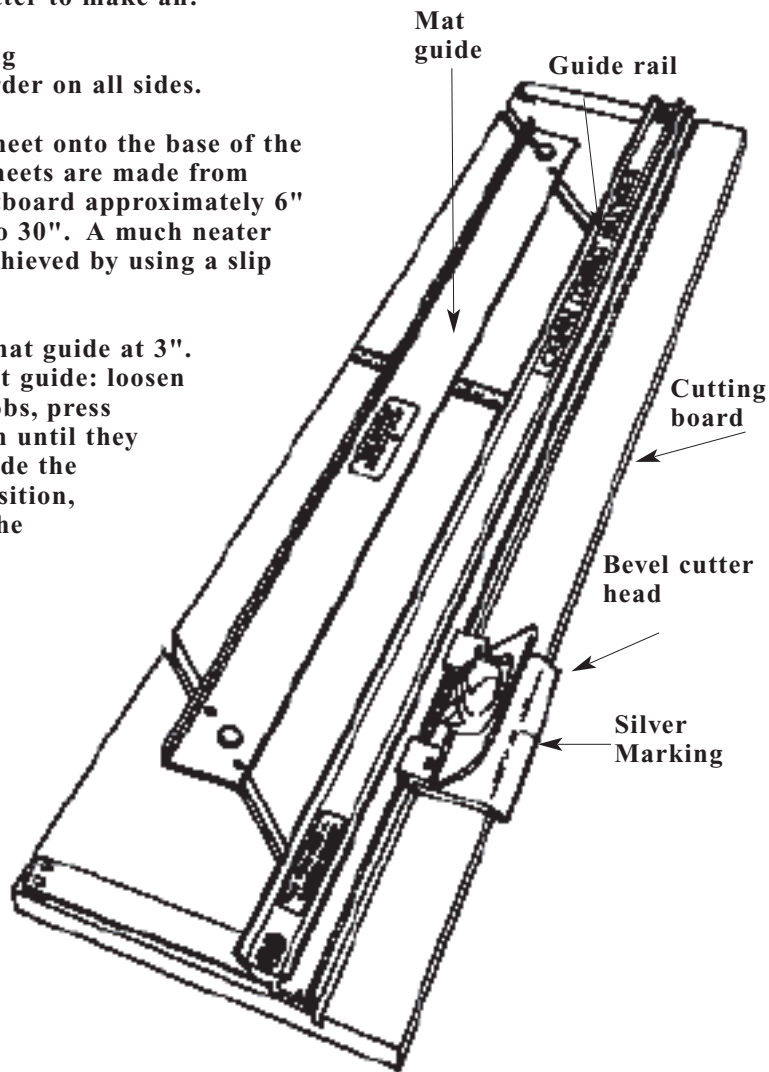

Compact Mat Cutter

5. Set the bevel cutter at the bottom intersection where the pencil mark intersects the rail edge. Line up the silver marking on the side of the cutter with the pencil line.
6. Hold the cutting head still with the left hand while pushing the blade into the board.
7. Push the bevel cutter forward and stop on the pencil mark intersection at the top of the mat.
8. Repeat this procedure on the remaining three sides.

**When using the Logan Simplex mat cutter, pictured at right, align matboard flush with the mat guide and squaring arm, insert blade at top marks on mat, and pull the cutting head towards the squaring arm until touching the stop.*

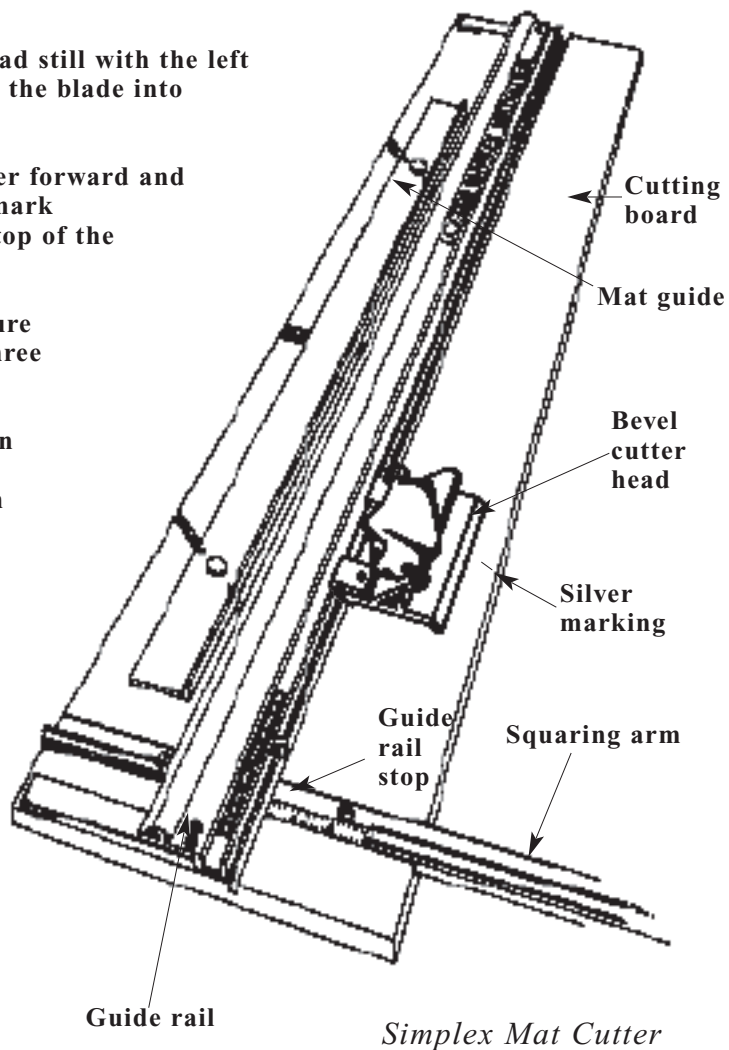

THE DOUBLE MAT

This method of cutting double mats will result in a perfect border every time.

1. Trim a Gray 11 x 14" top mat.
Trim a White 10-3/4 x 13-3/4" liner.

The purpose of cutting the liner matboard smaller is to keep its edges from interfering with the measurements on the first set of cuts.

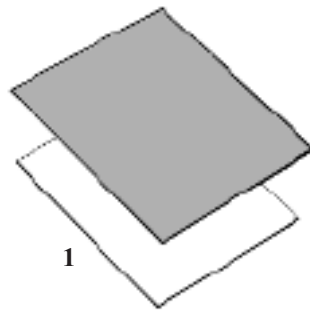

2. Set a slip sheet in the cutter. Put Gray board into cutter *face down* and cut a 2-3/4" border; save the fallout.

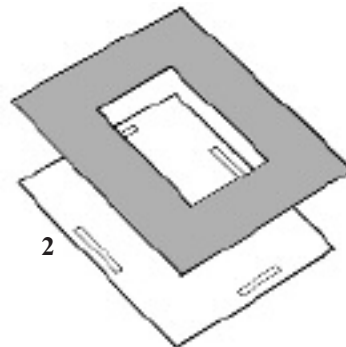

3. Apply four strips of double-sided tape on the face of the White board and attach it to the back side of the Gray board.

4. Take the Gray fallout and tape it back into place with a 1" strip of double-sided tape to make it easier to cut the next opening.

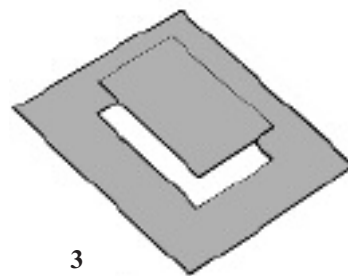

5. Set mat guides at 3".

**6. Insert the two taped-together mats
face down with the fallout in place, then
cut the 3" border on all four sides.**

**NOTE: Remove the tape from the sides and
bottom. The tape may be left in place on small
mats but when mats are larger than 11 x 14",
the tape may cause buckling over time.**

**It is best to use tape on the top side of the
mats only to allow the boards to expand and
contract with changes in humidity.**

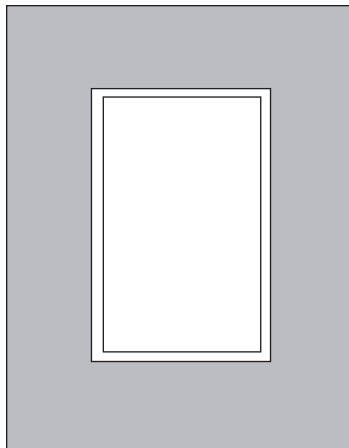

*The inner mat will be perfectly parallel to the
outer mat if you use this technique.*

MAKING A GUIDE FOR

This guide can be made from matboard and is handy when laying out decorative mats requiring parallel lines.

By using this type of ruler you will only have to mark off the four corners rather than draw full lines that will later have to be erased.

1. Using a mat cutter, paper cutter, or a T-square and utility knife, cut the triangle and the rectangle pictured on the right. Accuracy counts. Make them straight.
2. Glue the two pieces together with white glue. Make sure the triangle is accurately positioned on one of the short ends. Line up the long side of the triangle with a short end of the rectangle.

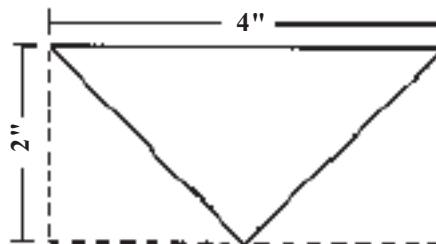

DECORATIVE BORDERS

3. Choose one of the rulers on this page and transfer the measurements to the guide or make a photocopy and cut and paste it in place. White glue or double-stick tape will attach the guide.

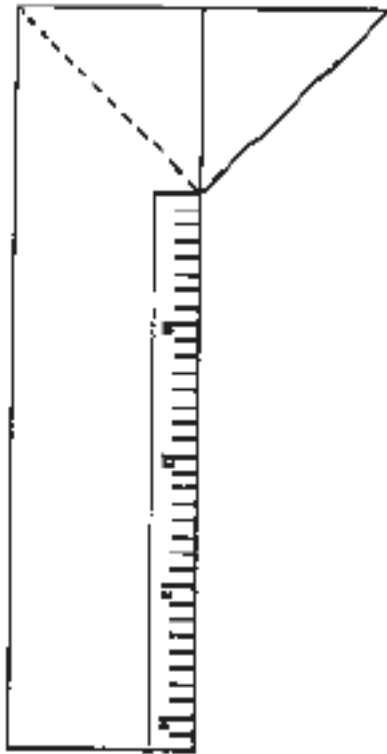

TIPS AND TECHNIQUES

- Consider style, size, color and proportion when designing mat decoration. Plan the design, then mark placement of design elements on the mat. Use a hard lead pencil with a light touch to create thin, light lines and dots that will be easy to erase.
- “Clean up” rough bevels with very fine sandpaper or neutral colored emery boards. Using sharp blades and slip sheets will help prevent rough cuts.
- Small scratches, scuffs or indentations in the mat can be corrected by gently moistening the area with a clean, slightly damp paintbrush, sponge, or cotton swab. Test first in an inconspicuous area to make sure that dampness will not cause waterspotting.
- Many marks and surface spots can be removed or at least minimized by gently scraping with a razor blade. Careful not to press too hard or dig the point in too deep, or the mat’s surface paper will be scratched.
- A loop of removable tape, wound around a finger with the adhesive side facing out, can be gently tapped or very gently pressed against surface imperfections to lessen or remove them.
- Erasers can be very useful for cleaning up many types of marks on matboards. Different types of erasers behave very differently. Have several kinds on hand and test in inconspicuous parts of the mat to see which will be most effective. Artgum® and white plastic erasers are very versatile.
- Do not try to erase grease marks from matboard; the eraser only pushes the grease deeper into the board. Try sprinkling a teaspoon of cornstarch on the spot. Allow the starch to absorb the grease, then brush it away. If that fails, try a commercial spot remover, following the instructions on the product label. Test product on scrap board first.

MATBOARDS

Matboards are made especially for use in picture framing. The center core of the board is specifically made to be white, or in some cases black or a few other colors.

The surface paper is a thick covering of art paper. Fade and bleed resistant, unlike other types of craft paper and boards, matboard surface papers are made to last significantly longer than poster boards and wrapping papers.

Cuts can be made into the surface for decorative accents. The cuts can be made with several tools and the designs can be very subtle or quite elaborate. They also can be combined with other types of decoration.

V-grooves are classic designs used by professional framers. They can be done with a V-groover tool or with the straight-line mat cutter.

Accent cuts, called cut-aways, can be done with a pencil-style knife or with a hand-held cutter.

Tools are shown on the following page.

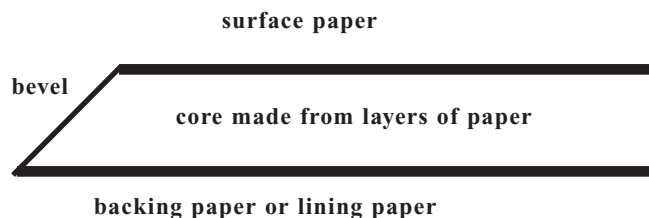

TOOLS

FOR SURFACE CUTS

Rulers—A cork-backed ruler is great for mat decoration because it stays in place without sliding and is easy to clean. Also, the cork layer raises the straightedge of the ruler slightly above the working surface, allowing the pen, brush, etc., to make clean, consistent lines on the surface.



Ruler

Hobby Knife— There are several different style knives to choose from. The pencil-style handle is best for decorative mat cutting. It is comfortable to hold and easy to maneuver. The narrow, fine point blades allow precision.



Hobby Knife

Blades—Sharp blades are an important part of successful mat cutting. Don't try to economize by using blades that have lost their edge. Some types of boards dull blades quickly and require even more frequent changes.

Hand-held Cutter

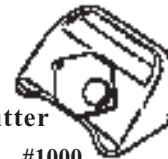

#1000

Hand-held cutter—Several hand-held models are available. Along with a ruler and T-square, these cutters can be used to trim boards square and to cut mats with beveled edges. They can also be used to make V-grooves and other decorative cuts.

V-Groover—This is an add-on attachment for mat cutters that allows easy cutting of consistent V-grooves.



#703

V-Groover

HAND KNIFE TECHNIQUE

Practice using the small hand-held knife on the matboard surface. Cutting the surface papers can be done with one slice, but it may take 2 or 3 slices before cutting completely through the matboard.

Change the blades often for sharp, clean cuts.

The angle at which the knife is held is important, as well as the amount of pressure.

Practice will help release the tension from your hand. Smooth cutting will come with practice and sharp blades.

Stabilize the thin blade by pressing a finger against one side of the blade.



Hand-held knives can be used in either the left or right hand.

CUTTING A V-GROOVE

USING THE *SIMPLEX V-GROOVER*

1. Set squaring arm stop at 2".
2. Place spacer bars flat against the squaring arm. If spacer bars are not being used, set the stop 1/2" less than the desired V-groove measurement.
3. Set the guide rail stop at 2".
4. Place matboard in cutter *face up*.
5. Place V-groove stop onto guide rail and lock into place. Make sure the foot of the stop rests against the top edge of the matboard. Set scale at 2".

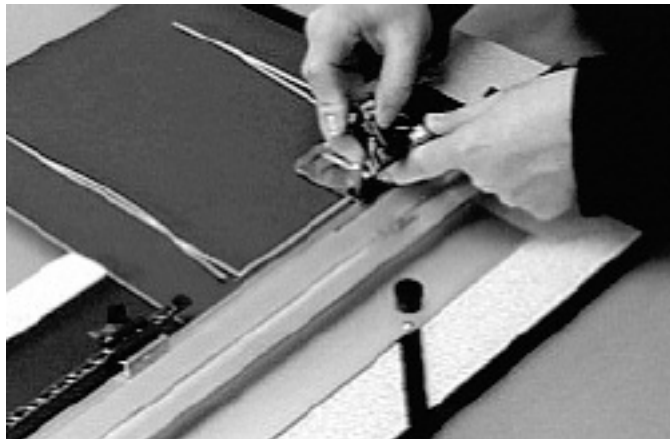

- 6. Place the thumb of right hand on the V-groove label and place the index and middle fingers on the front of the base.**
- 7. Use left hand to push on the left lever handle (note arrow direction on lever), hold down and *push* the cutting head from the bottom to the top (the V-groove stop).**
- 8. Use left hand to push on the right lever handle (note arrow direction on lever), hold down and *pull* the cutting head from the top to the bottom.**
- 9. Reposition the matboard and cut the remaining three sides.**

If corners are still slightly connected after all four sides have been cut, use a razor blade to carefully finish the separation.

OFFSET CORNER V-GROOVE

USING A LOGAN *V-GROOVER*

1. Set both the top and bottom stop at 2".
2. Set the mat guide to 1-1/2". If you are using model #703, remember to account for the 1/2" offset by using the spacer bars or adjusting the mat guide to 1".
3. Place the V-groove cutting head on the rail as usual and cut all four sides. None of the V-groove strips will fall out at this time. This is intentional.
4. Set both the top and bottom guide rail stops to 1-1/2".
5. Set the mat guide to 2". Once again, if you are using model #703, remember to account for the 1/2" offset by using the spacer bars or adjusting the mat guide to 1-1/2".
6. Place the V-groove cutting head on the rail as usual and cut all four sides. This time the corners will all meet and the strips can be removed from the board.
7. Set both top and bottom stops and the mat guide at 1-3/4". If you are using model #703, remember to account for the 1/2" offset by using the spacer bars or adjusting the mat guide to 1-1/4".
8. Place the V-Groover cutting head on the rail as usual and cut all four sides. This step cuts a V-groove in between the offset grooves cut already, creating a more dramatic look.
9. The mat is now ready for a beveled window (see pages 8&9).

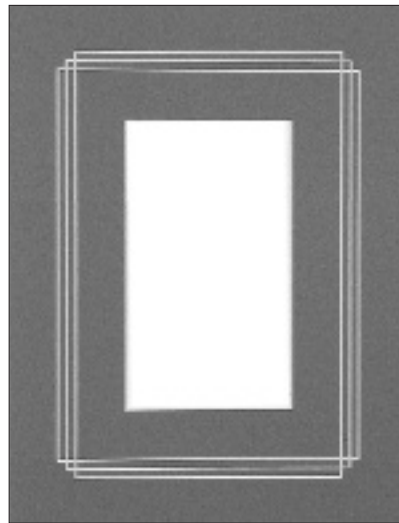

INSIDE ANGLE V-GROOVE

USING A LOGAN *V-GROOVER*

1. Set both the top stop, bottom stop and mat guide at 2". If you are using model #703, remember to account for the 1/2" offset by using the spacer bars or adjusting the mat guide to 1-1/2".
2. Cut a complete V-groove.
3. Using a ruler, measure 2" from each 90° corner and make light marks with a pencil on the outside of the cut V-grooves. Do this on each of the four corners.
4. Place the mat into the machine at an angle along the guide rail.
5. Space the two pencil marks 1/2" from the edge of the guide rail. If using the #703 *Simplex V-Groover*, use one of the spacer bars provided to line up the pencil marks. Remember that all Logan V-Groovers cut 1/2" away from the guide rail.



Note: If using the #705 or #706 *V-Groover*, the 1/2" offset must be compensated for on the left side of the guide rail.

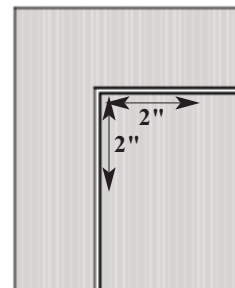
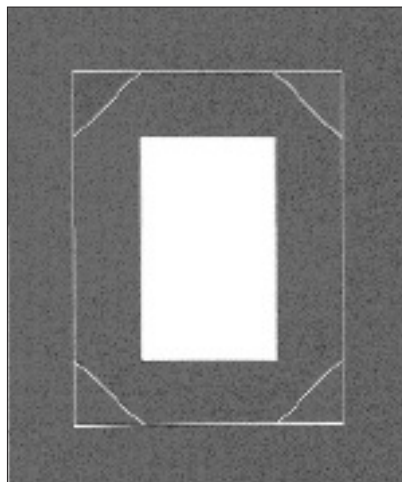

6. Place the V-groove cutting head on the rail over the V-groove nearest you.
7. Looking down between the blade holders, press the left blade holder down so that the top is in the center of the cut V-groove.
8. Slide the V-groove cutting head away until it bumps into the other cut V-groove.
9. Lift the blade lever and insert the right blade lever.
10. Slide the V-Groover cutting head back until it bumps into the first V-groove. The angle cut strip of matboard should now fall from the board completing one corner.
11. Repeat steps 6 through 10 to complete the mat.
12. Use a soft eraser to gently remove the light pencil marks.

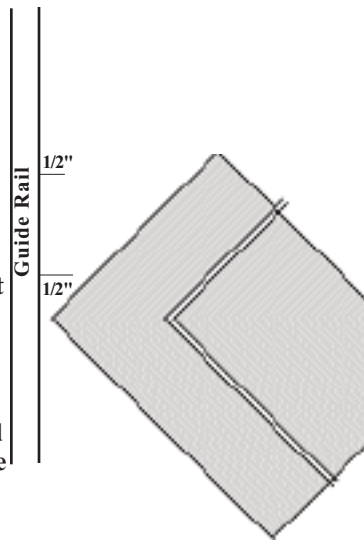

CONNECTING ANGLE V-GROOVE

USING A LOGAN *V-GROOVER*

1. Set the top and bottom stops at 4".
2. Set the mat guide for 2". If you are using model #703, remember to account for the 1/2" offset by using the spacer bars or adjusting the mat guide to 1-1/2".
3. Cut all four sides. None of the V-grooves will meet at the corners and the V-grooves will remain unfinished.
4. Using a pencil, mark the end of the cut on each unfinished V-groove.
5. Place the mat at an angle underneath the guide rail.
6. Space the ends of two unfinished V-grooves 1/2" away from the guide rail. If you are using the #703 *Simplex V-Groover*, use one of the spacer bars provided to line up the pencil marks. Remember that all Logan *V-Groovers* cut 1/2" away from the guide rail.

Note: If using the #705 or #706 *V-Groover*, the 1/2" offset must be compensated for on the left side of the guide rail.

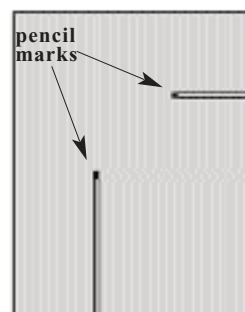
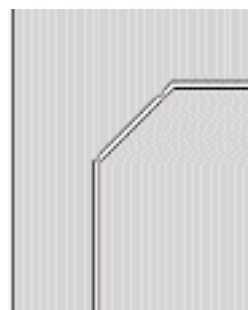

7. Place the V-groove cutting head on the rail above the nearest unfinished V-groove.
8. Looking down between the blade holders, insert the left blade down into the small pencil mark at the end of the unfinished V-groove.
9. Slide the cutting head away and stop when directly over the pencil mark on the unfinished V-groove farthest away.
10. Lift the left blade lever and insert the right blade lever.
11. Slide the cutting head back towards the nearest unfinished V-groove and stop directly over the pencil mark. This should allow the V-groove's strips to fall from the matboard.
12. Repeat steps 7 through 11 on the remaining three sides.
13. Use a soft eraser to gently remove any pencil marks.

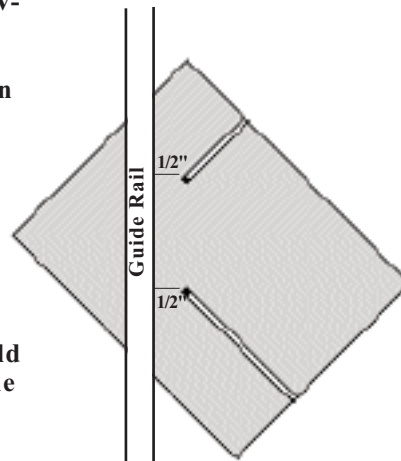

CUT-AWAY DESIGNS

This style of decoration works well on dark or deep color matboards with white cores or a light colored surface with a black or colored core.

Designs such as:

- Teddy Bear on dark brown
- A Sailboat on deep water blue
- Stars on dark blue
- Country House on country red
- Sea Shell on pale rose
- Scotty Dog on red surface Black Core
- Graduation Cap on white surface Black Core

Core

Materials:

- 11 x 14" matboard with a 3" border
- hobby knife or Logan #1000 hand-held cutter
- Burnisher
- Tracing Paper
- Design or stencil
- Soft and hard lead pencils
- Removable tape

1. Place tracing paper over design and trace.

2. Rub back of tracing paper with soft lead pencil.

3. Transfer design by setting the coated tracing paper onto the surface of the mat. Secure with a removable tape. Then retrace drawing onto matboard with hard lead pencil.

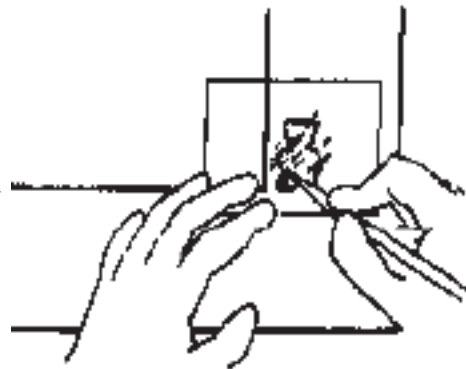
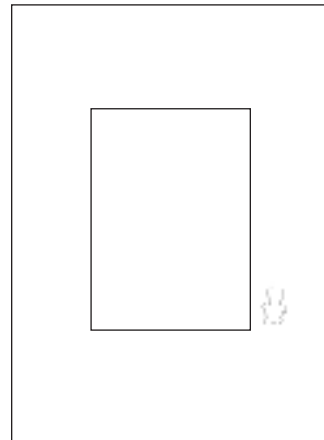

4. Using knife or hand-held cutter, cut the surface paper of the matboard.
5. Carefully peel away cut areas.
6. Burnish the cut-out areas with a round smooth object.
7. Color may be added by using acrylic paints applied with a fine soft brush.

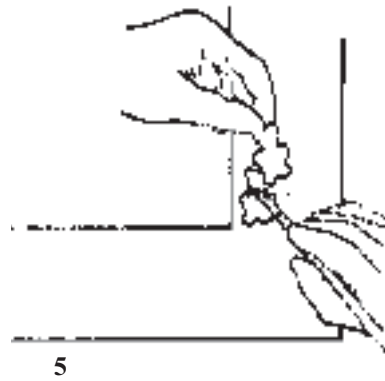

Cutting a design with the Logan #1000 hand-held cutter.

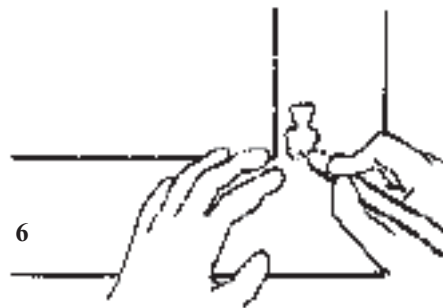

DESIGNS FOR CUT-AWAYS

The designs on these two pages may be traced and transferred to a mat using the directions on pages 25 and 26.



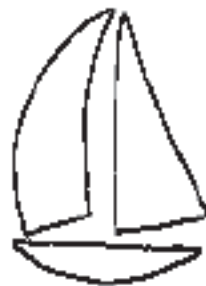

LINEAR CUT DESIGNS

Materials:

11 x 14" matboard
hobby style knife
Designs to trace
Rule
Tracing Paper
Soft and Hard pencils

This method is similar to the Cut-Away Design on pages 25 and 26.

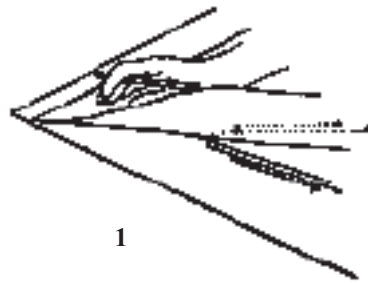

1

1. Trace the chosen design and transfer to the matboard.
2. Using the pencil style hobby knife and a rule as guide, cut into the face of the board without going all the way through. Hold the knife at a 45° angle to get an open cut.
3. Turn the board around and slice opposite of the first cut. Each line of the design will require two cuts that face each other to form a handmade V-groove, which will expose the center core.

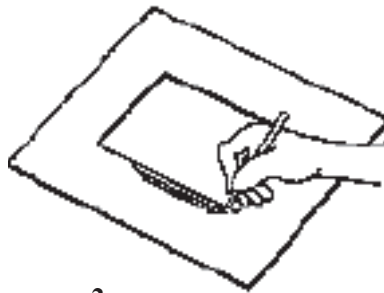

2

4. Carefully remove the cut-out pieces from the design.

DECORATED BEVELS

PAINTED/COLORED BEVELS

Method One

Materials:

11 x 14" matboard

Water-base markers

or

Acrylic paints and short bristle brush

or

Gold or silver capillary style markers

1. Set 11 x 14" mat with 3" border *face up* on a scrap of matboard.
2. Hold mat flat with one hand. Place marker in bevel and pull along the edge toward bottom.
3. Turn mat and continue until all four edges are colored, making sure color reaches all the way into the corners.

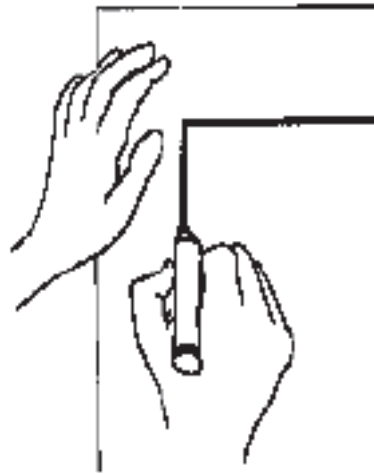

2

Method Two

Materials:

11 x 14" matboard

Water-base markers

or

Acrylic paints and short bristle brush

or

Gold or silver capillary style markers

Invisible tape

1. **BEFORE** cutting the border of the matboard, place four strips of invisible removable tape on the *face* of the mat in the same area where the mat will be cut. The tape should be somewhat centered over the area where the cut will be made.

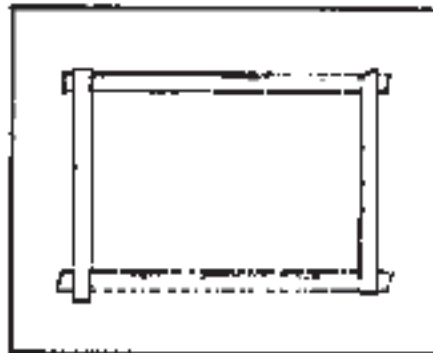

2. Place the mat *face down* and cut a 3" border as usual. The tape will be cut at the same time. The remaining tape will protect the mat surface while the bevel is being painted.

3. Set cut mat onto a scrap board *face up* and color the bevels with the marker or paints. Be careful not to push the paint up under the edge of the tape.

Do not use permanent markers because they will absorb into the matboard bevel very quickly and spread onto the face of the mat.

4. When the color has dried, gently lift the tape. Although the tape is removable, it may stick to some surfaces, so pull it up slowly.

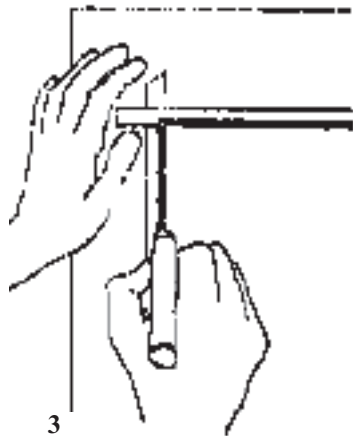

Using Markers

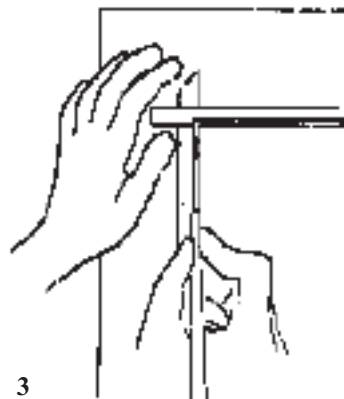

Using a Paintbrush

PAPER FILLET

Materials:

11 x 14" matboard
Decorative papers such as:
Marbled papers
Thin wallpaper
Quality wrapping paper
Invisible mending tape

1. Cut a 3" border in the matboard.
2. Cut two 1 x 7" pieces and two 1 x 10" pieces of decorative paper.



3. Fold pieces length-wise.
4. Place mat *face down* and set folded paper along the opening, allowing the paper to extend 1/4" into the opening.
5. Align and secure papers with a permanent polyvinyl tape or a permanent invisible tape to the back side of the mat.
6. The overlapped corners will not show if the paper is patterned.

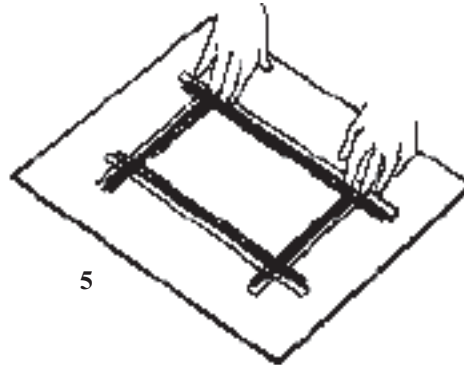

RUB-ON DESIGNS & MONOGRAMS

Materials:

1/64" or 1/32" charting tapes (art supply stores)
1 sheet of 1/4" rub-on transfer alphabet
Burnisher
Decorative border guide (see pgs 12,13) or a T-Square
Pencil
Razor blade or hobby knife

1. Using a pencil and a T-square or the decorative border guide, mark the position of the tape on the front of the mat.
2. Set tape onto the face of the mat—careful not to stretch it. Pat it down.
3. Allow tape to intersect and overlap at the corners.
4. Use a razor blade or a hobby knife to miter the tapes.
5. Lift off loose ends.
6. Use blade point to align corners.

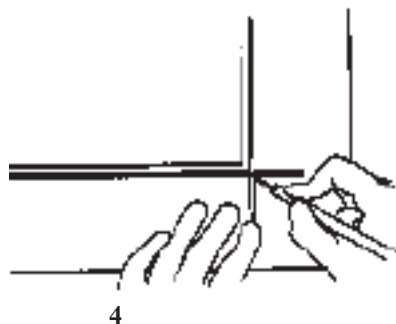
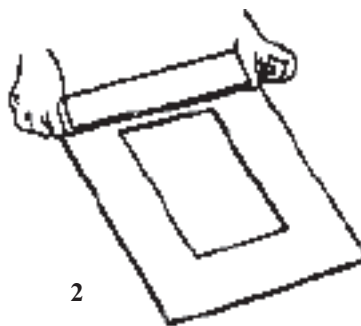

7. To apply the monogram, choose an area on the mat and cut away a section of the charting tape.

8. Transfer the letters to the matboard by rubbing on the face of the transfer letter sheet with a burnisher.

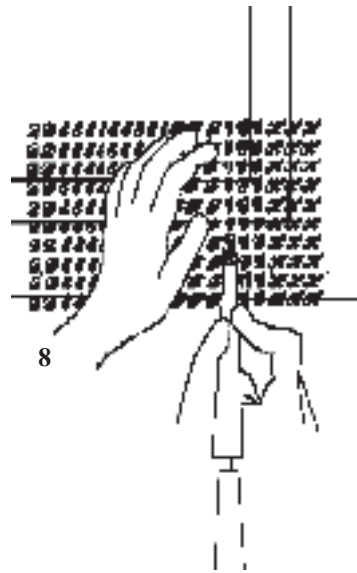
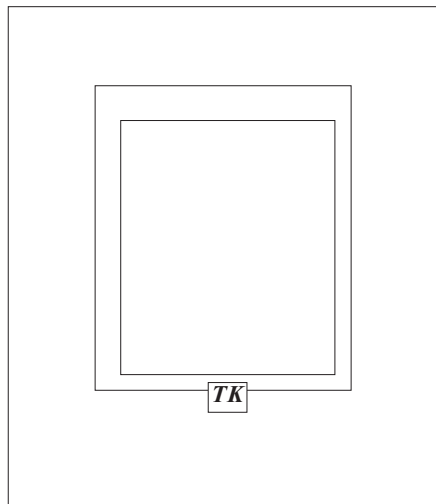

Tapes can also be applied to the bevel of the mat using 1/8" charting tape from art supply stores.



RUB-ON DESIGNS

Various rub-on designs are available to decorate matboards.

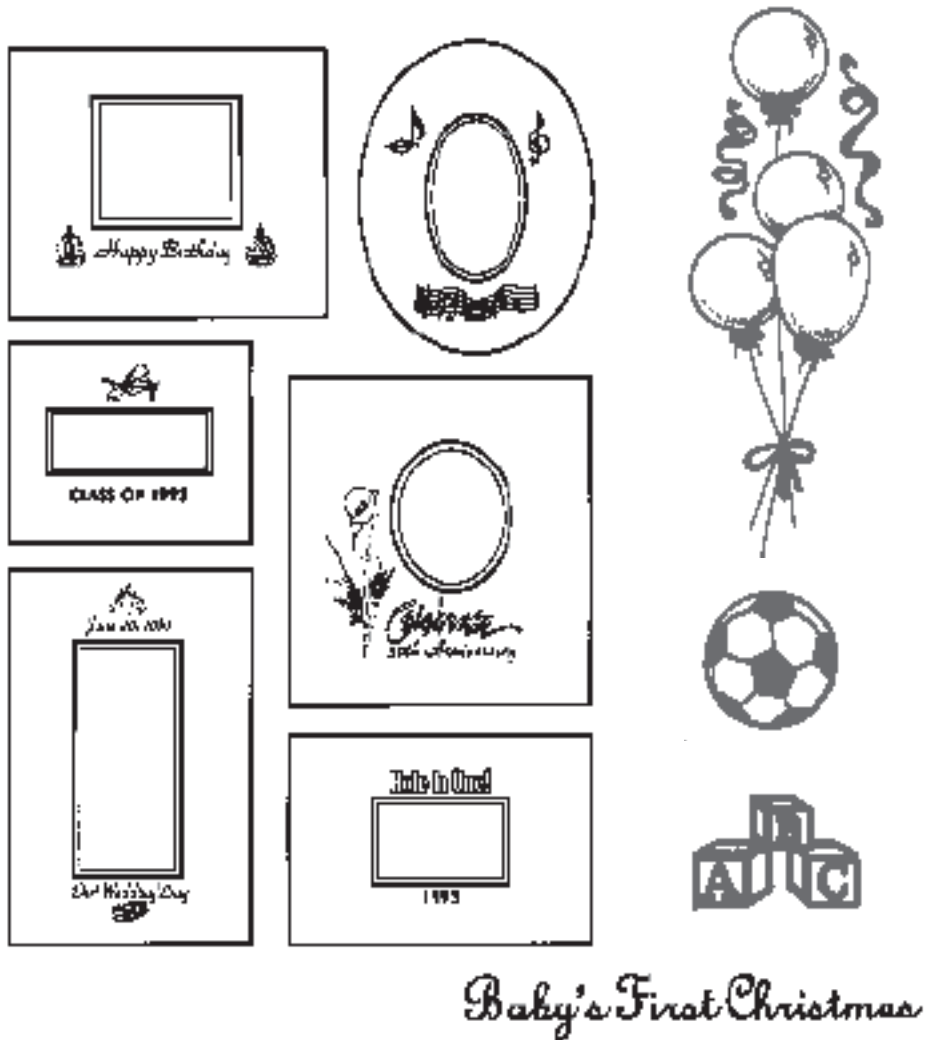

Illustrations and rub-on designs pictured here are made by *Chartpak*.

STENCIL DECORATION

Add a decorative accent to echo a feature in the artwork.

Materials:

11 x 14" matboard with a 3" border
Acrylic paints
Stencil brush or scrap fabric
Scrap of glass, small plate or bowl
Mylar® or acetate
Invisible tape
Hobby knife
Design

1. Place Mylar over design.
2. Cut out shapes with knife—careful not to overcut.
3. Squeeze acrylic paint onto scrap of glass, or into a small plate or bowl.
4. Dab scrap of fabric or stencil brush into paint—practice dabbing on a scrap board.
5. Place stencil over area to be painted. Hold stencil in place with invisible tape.
6. Dab paint on stencil.
7. Lift stencil and let stencil dry.
8. Several colors may be used – simply block out area of the stencil with invisible tape and remove when needed.

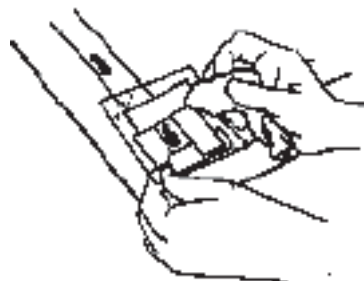
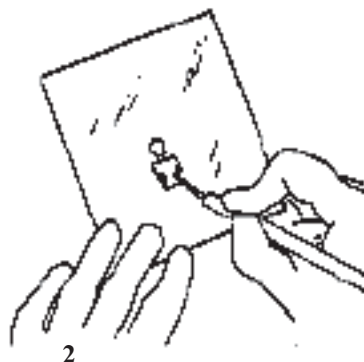

DESIGNS FOR STENCILS

These designs may be traced and used as stencils.

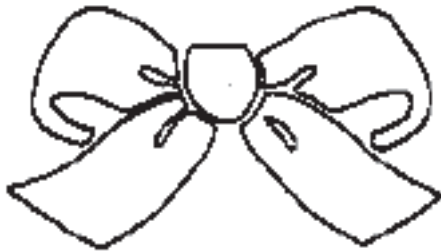

INK LINES

RULING PENS

Ruling pens are old fashioned graphic arts pens. The purpose of using these pens to draw decorative lines is they will hold almost any ink, watercolor or paint. So using thick metallic paints is also possible using a ruling pen.

The lines may be any size from thick to thin because the pen has a screw adjustment on the side of the barrel.

A ruling pen consists of two blades, a center screw and a handle. The center screw can be adjusted to change the width between the blades which in turn determines the width of the ink line.

Ruling pens are available in different qualities. The better the pen, the smoother it will operate.

FILLING A RULING PEN

Always make sure to fill the pen away from the mat so that the mat will not be damaged if the ink overflows from the pen while filling.

1. Set the blades to the desired width. The farther apart the blades, the wider the line.
2. Hold the pen at a slight angle or the ink will fall out.
3. Using an eyedropper, which may be on the inside of the cap of the ink bottle, or a brush, drop some ink between the blades.

Thicker paints will require a wider blade setting.



RULING PEN TECHNIQUE

- Before filling the ruling pen with ink, draw several imaginary lines on a scrap of matboard to get used to holding the pen at the proper angle. If the pen has rough spots, carefully use an emery board to “sand” the edge smooth.
- After filling the ruling pen with ink, practice many lines, both thick and thin until you feel comfortable with the pen.
- Make sure the pen is working properly and the line is the proper width.
- If the pen is sitting for a few minutes, the ink may dry. Dry ink will not allow the pen to function properly.

Keep both blades on the paper or matboard. They both must touch the board since the width of the blades determines the width of the line to be drawn.

Do not twist the pen while drawing the line; it will cause a skip in the line.

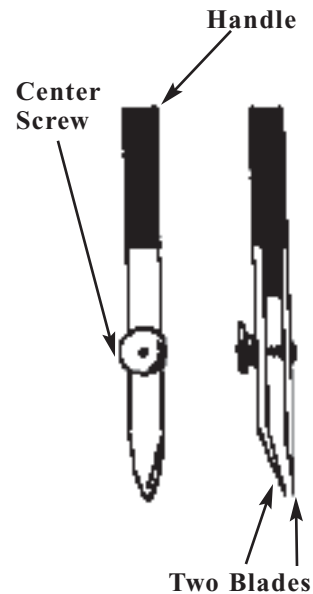

Use the pen at an angle — not straight up and down.



Make sure both blades touch the surface of the mat.



MAT DECORATION WITH INK LINES

Materials:

11 x 14" mat with opening cut
Ruling pen
Permanent Artist's ink
Decorative border guide (see pgs 12,13)
Straightedge
Pencil

1. Cut a mat with a 3-1/2" border.
2. Using decorative border guide, lightly measure off desired lines from the bevel.
3. Line up straightedge with marks.
4. Fill ruling pen with ink and test on a piece of scrap board.

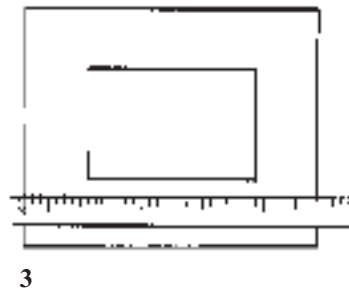
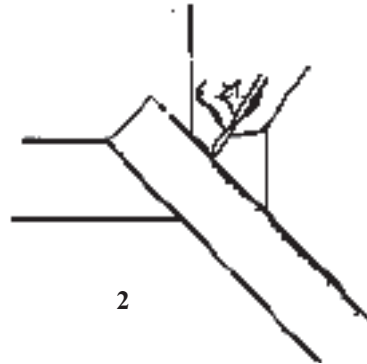

5. If more than one line is to be drawn, start with the one closest to the mat opening so that the next line may be started without waiting for the previous line to dry.

6. Place the ruler where line is to be drawn.

7. Place the tip of the pen at the exact starting point and draw the pen slowly along the straightedge.

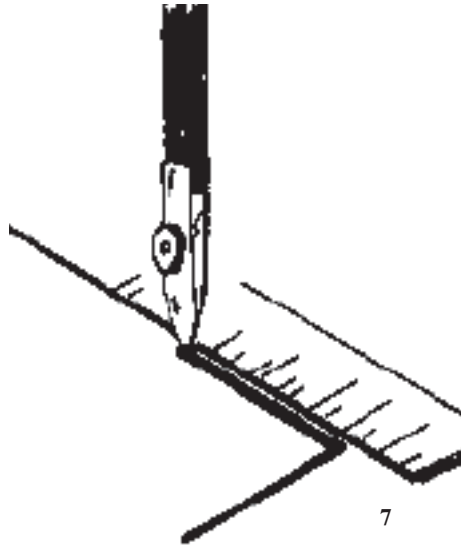

Note:

If the line is very long, the pen may run out of ink. Stop before it runs out, refill the pen, test it on a scrap of board then set the pen exactly next to the end of the wet line and continue drawing. The two lines will connect, if they are both wet.

Take care not to move the ruler or the screw on the side of the pen.

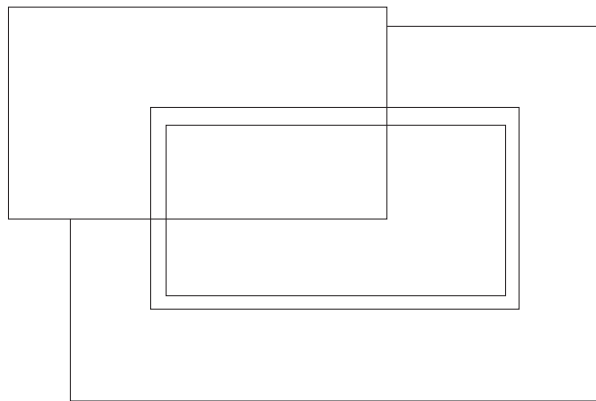

CORRECTING OVERRUNS

In case of an ink line overrun:

1. Do not attempt to correct the overrun while the ink is wet since this will result in a permanent smear.
2. Before the ink has time to cure, but after it is dry (generally a few hours), slice the ink where the line should have ended using a sharp razor blade.
3. Stand razor blade perpendicular to mat and gently scrape the ink off.
4. Clean the board's surface with an eraser.

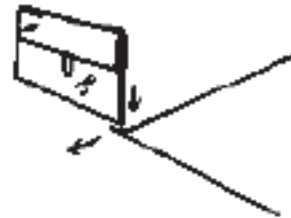
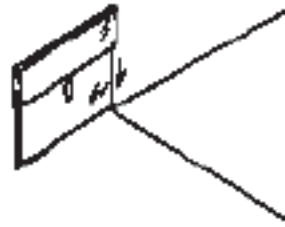

COLOR PANELS

USING WATERCOLORS

The traditional method uses a painted wash panel with several inked lines. Using various colors of paint and inks with varying sizes of panels and lines will render unlimited decorative embellishment. The ink lines must be permanent while the color panel is watercolor.

Materials:

Good quality matboard
Artist's transparent watercolor
Permanent ink & straight ruler with a cork underlining
Hard pencil & ruling pen
Decorative border guide (see pgs 12, 13)
Soft hair watercolor brush
Mixing cup

1. Cut a mat with a 3-1/2" border.
2. Using decorative border guide, lightly measure off 4 lines from the bevel. Vary the distance between each line to keep the design balanced.
3. Line up ruler with marks.
4. Fill ruling pen with ink.

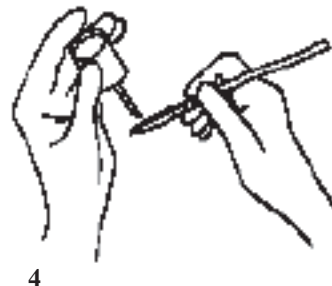
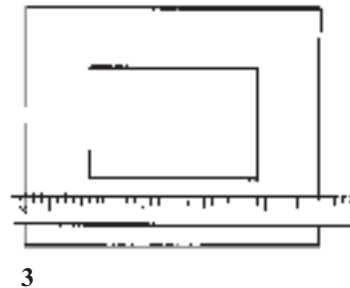
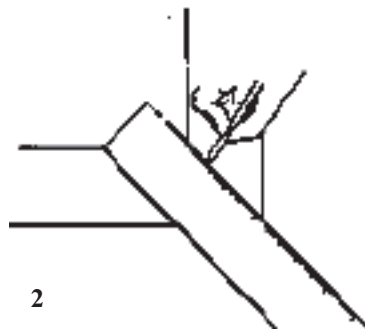

- 5. Draw each line with one continuous stroke. Start with the line closest to the bevel. Draw all four lines on one side. Do opposite side. Let both sides dry. Do remaining two sides. Let dry.**

Note: If the matboard is not specially sized for color-wash panels, spray the board with a Workable Spray Fixative.

As a result of spraying the board, the ink lines will hold tight and the paints will distribute evenly. Not all sprays are the same—Check the can label to see what works.

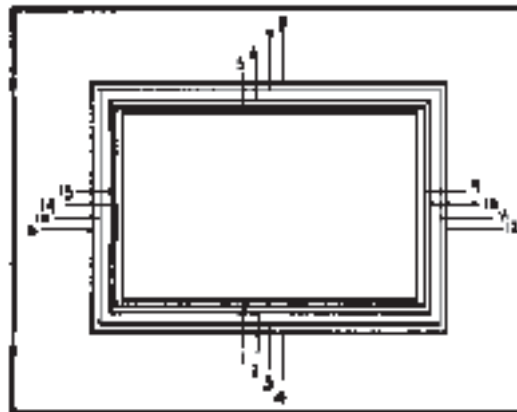
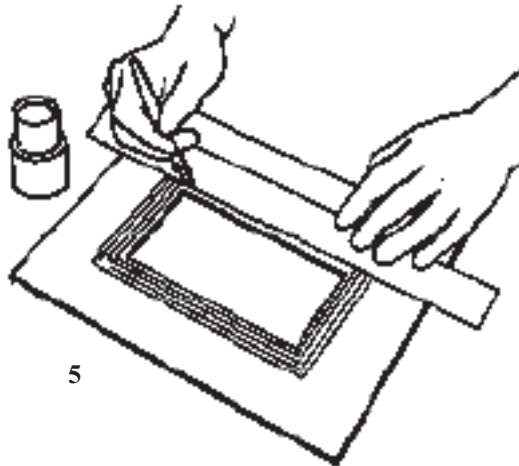

6. Before applying watercolor, brush clear water into the panel area to lightly wet it. This permits the watercolor to be “worked” and absorbed evenly.
7. Put a dab of watercolor in a cup and dilute with water. Test on scrap board for intensity. If the mat is very large, a small amount of glycerin may be added to slow the drying time of the watercolor.
8. When satisfied with the color, start one inch away from any corner and pull the puddle of watercolor around the panel. Do not let the puddle dry up; keep adding more watercolor. When approaching last corner, let up on the watercolor, wipe the brush on a paper towel to reduce the amount of color you are carrying, then continue around the last corner.
9. A second coat may be put on right away—it will make the color more intense.

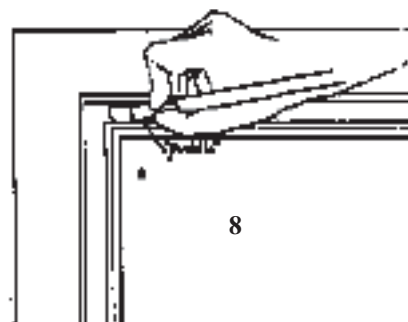
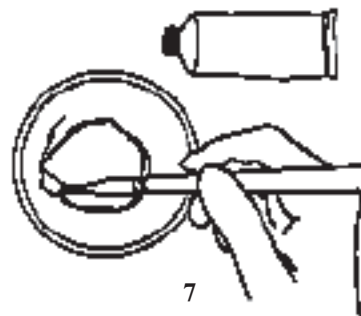
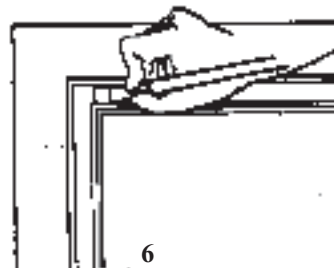

COLOR PANELS USING CHALK PASTELS

Materials:

Artist's soft pastels
Liquid acrylic paints
Permanent ink
Decorative border guide (see pgs 12, 13)
Ruler
White vinyl eraser
Hard pencil
Razor blade
An artist cleaning pad/gum Eraser
Two poly foam brushes

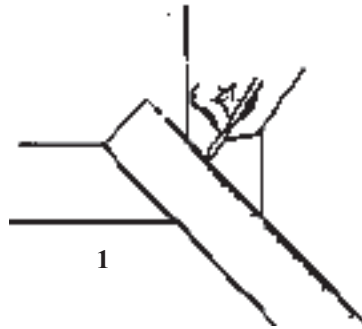

1. Use dots to mark board using the decorative border guide or a rule.
2. Fill ruling pen with liquid acrylic paint or permanent ink.

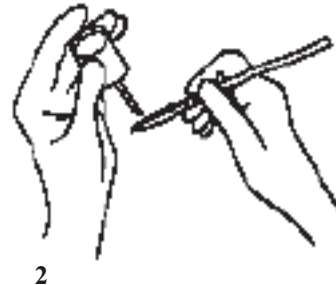
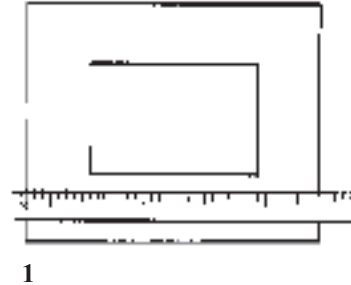

3. Line up rule with dots and apply ink lines closest to the bevel first, working your way outward. This method allows each new line to dry undisturbed while working on the others. Let them dry thoroughly. If you have an overrun, use a razor blade to cut and flake off excess (see Correcting Overruns on page 43).

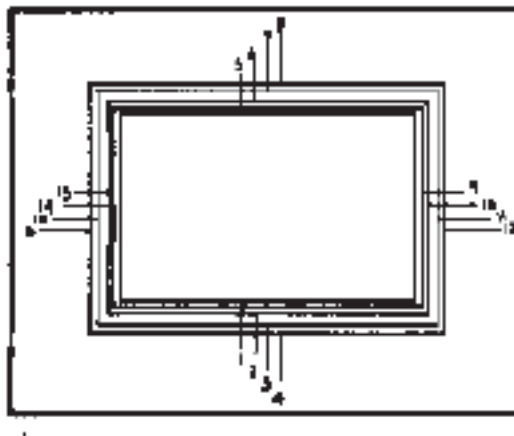
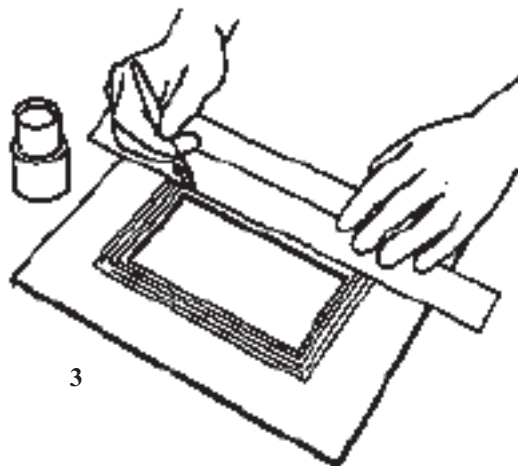

4. Create a color powder by scraping soft pastels with a razor blade. Prepare several colors before starting to color your panels.
5. Clean entire board with an artist cleaning pad.
6. Apply powder to the panel with a poly foam brush—which can be cut to any shape. Do not scrub color into board. Rub gently onto board.



4

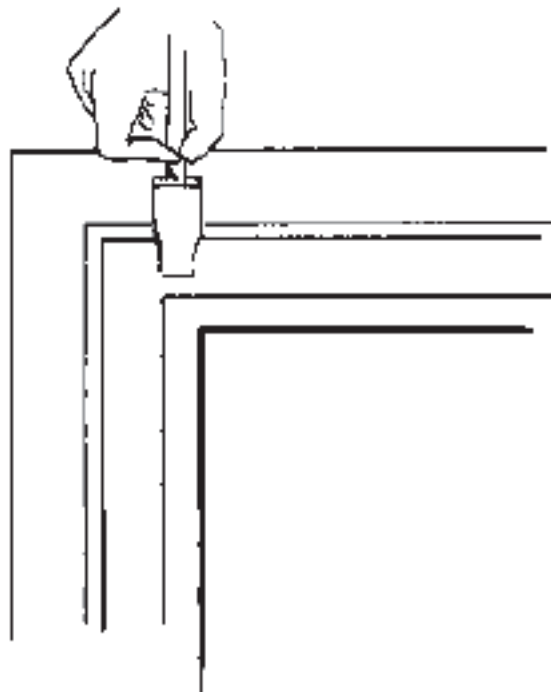

6

7. **Work powder around inside edge of panel. Then apply to the opposite side of the panel and blend towards the middle.**
8. **Remove excess powder with a clean poly foam brush.**
9. **When complete, pull a white vinyl eraser around the edges to clean up.**

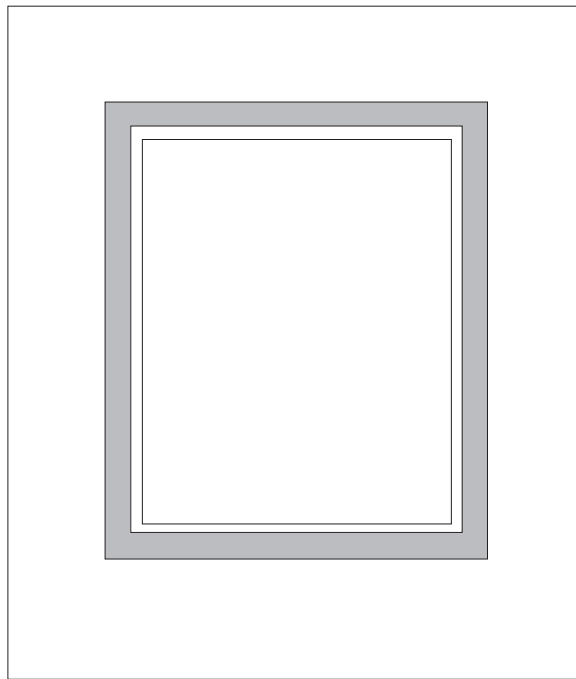

DECORATING WITH RUBBER STAMPS

Rubber stamps are available in a huge variety of designs. Used with ink pads made for stamps, or with markers or acrylic paints, rubber stamps offer a great opportunity for creative fun on smooth matboards.

Cut the mat first and use the fallout for practice with the stamp. Test inks or paints for surface bleeding.

Remember that the block holding the stamp design is larger than the design area itself. Set inked stamp on practice board, design side down, and trace around the block. Lift the block and see how the design size and position relates to the overall size of the block.

Now use light, erasable pencil lines to mark placement of the block on the actual mat, so that designs will be created exactly where desired.

Even if creating a random pattern of stamping, it is best to practice first on a scrap piece of board, to determine the best spacing for a pleasing randomness.

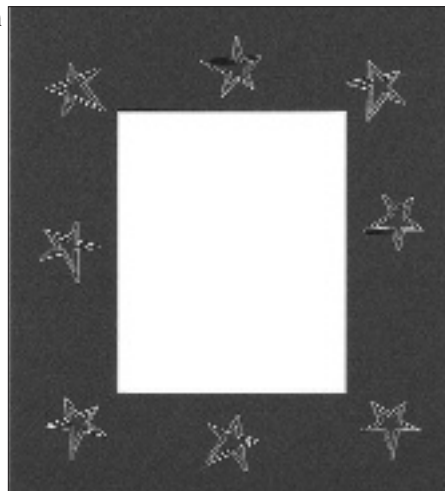

DECORATIVE ITEMS

Many items can be used to decorate mats:

- buttons
- beads
- birdseeds
- feathers
- sequins
- dog biscuits
- dried flowers
- silk flowers
- paper dolls
- appliques

Pieces can be attached to mats by sewing or using silicone adhesive. Hot glue may also be used, but may not have the longevity of the other methods.

Use imagination and let the artwork being matted guide color scheme and design.

If mats decorated with three dimensional items are to be framed, extra depth in the frame will be required to keep the mat from buckling.

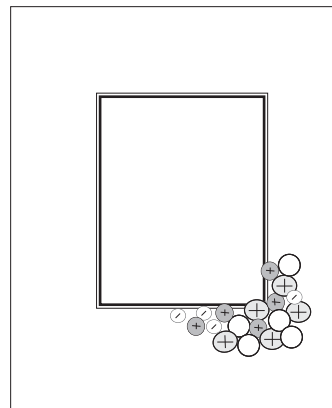

Use buttons of various sizes for a more interesting design. Attach buttons with thread, embroidery floss, or glue.

WOVEN RIBBON MAT

Materials:

Lt. Blue satin baby ribbon
Circle paper punch
Two 11 x 14" matboards
Med. Blue top matboard
Lt. Blue undermat
Invisible tape

1. Cut a 3" border on the Lt. Blue board.
2. Cut a 2-3/4" border on the Med. Blue board.
3. Measure the Med. Blue board for placement of holes for weaving.
4. Use a common paper punch. Punch holes in the planned places and save the fallout circles—they will be needed. If making the punch is difficult, use a hammer and tap lightly on the top of the paper punch. This will help cut through the board.

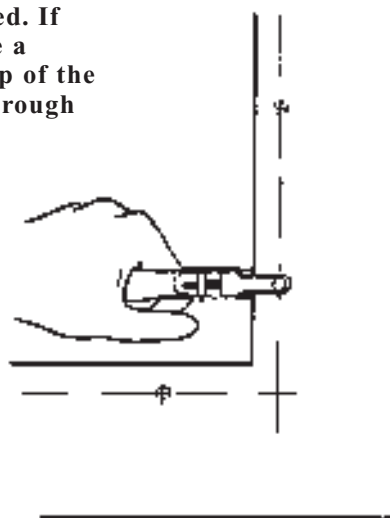
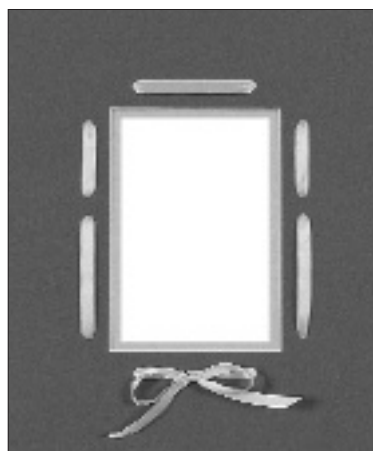

5. Start anywhere from the back and weave the satin ribbon in and out of the Med. blue matboard.

6. Before securing the ends, put the mat face down and replace the circles that fell out of the holes. This gives a rounded smooth effect where the ribbon comes out of the holes.

7. When you are satisfied with the lay of the ribbon on the front of the mat, secure the back side with strips of invisible tape.

8. Make a bow and attach it to the board. Be careful not to make the bow too thick or a shadow box will be required.

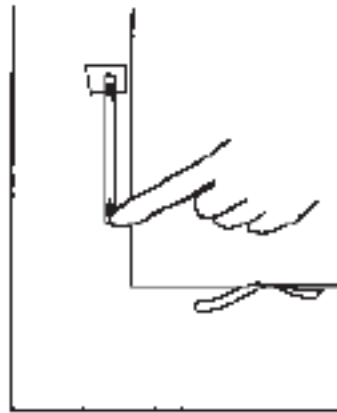

THREADED BORDERS MAT

This method creates a quick and easy decorative line around the mat opening. A variety of threads and strings may be used to achieve many different effects. Try two strands of embroidery floss for a subtle line, or four strands for a bold stripe. Use jute or raffia for a stronger design.

Mark placement on front of mat and poke holes in mat with a needle or pushpin. The hole should be just large enough for the selected thread.

For a continuous line around the mat opening: Make one hole at each corner. Use four separate lengths of selected thread, several inches longer than needed for each side, threaded through a needle. Come up through one hole, and go down through the next, then tape or tie threads at back of mat. Repeat on all four sides of mat.

For a line with a slight gap at the corners: Make two holes at each corner, about 1/4" apart. Begin "sewing" around the mat by bringing the threaded needle up at any hole and continuing down through the next hole, continuing around mat.

To hold threads firmly in place with no sagging, tape threads at corners on back of mat.

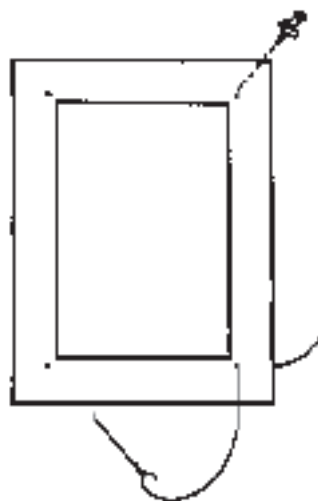
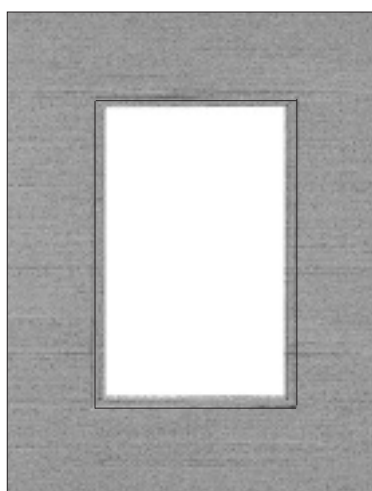

QUICK SHADOW BOX

This quick shadow box is made from a fabric-covered piece of matboard. Although it can be made from scrap regular board, a fabric board covers the folded seams, giving a clean, finished look.

Items can be held in position by sewing in place or attaching with stick-on Velcro®. How much depth should be created? Use just enough so the item does not touch the glass. Any additional space is for design or convenience.

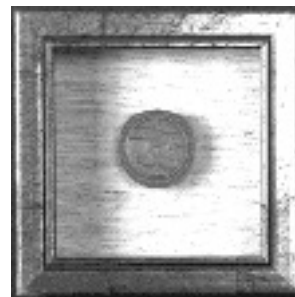

The Quick Fold shadow box is perhaps the easiest method to create both sides and background at the same time. Score back of board and fold as shown at right. Tape corners at outer edges.

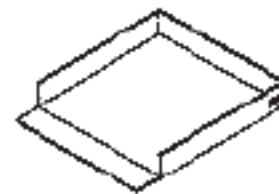

MEMORY BOOK

Matboards are perfect for the front and back covers of memory albums. Using a mat cutter will allow you to cut straight, clean edges and add some decorative techniques.

The covers can be decorated with the very same techniques you have used to decorate mats—rubber stamps, paints, V-grooves and fancy cuts.

Adding a mat to the cover will permit a central picture to be used to set the theme of the memory album.

Materials

Matboards
Paper punch
Loose papers for the interior of the album
Lace, string, ribbon, embroidery floss, or cord to bind the album together
Double-sided tape
Photograph
8 x 10" mat with opening cut for the photograph
Linen tape or invisible mending tape

1. Cut 2 matboards 9 x 12".
2. Place the matboard *face down* in the cutter. Set the guide rail to 1" for the side edge where the album will be bound.
3. Use a hobby knife to score the fold area. A score should cut through some of the fibers of the board but not all the way through.



4. The fold area will have to be reinforced with pressure-sensitive fabric tape. Use linen tape or invisible mending tape. Burnish the tape to the fold area and trim any excess tape from the edges for a neat appearance.
5. Measure for placement of the punched holes. Two holes or multiple holes can be used for a more decorative effect.
6. Hold the paper punch firmly, insert the matboard into the "mouth" of the punch, pushing the board in as far as possible. Punch the hole. Take care not to scratch the board while pushing the board into the mouth of the punch.
7. Repeat as necessary to create as many holes as the design requires.
8. Trim 50 sheets of coordinating paper to just less than the 9x12. Or use 8-1/2 x 11" copy paper, it works perfectly in a 9 x 12" album. Some office supply stores carry different types of papers. Look for a good quality paper with thickness and a texture to enhance the album design and properly support memory items.
9. Punch holes in the paper album pages in exactly the same place as the holes in the front and back of the album cover.
10. Place photograph in the mat opening and attach photo to mat. Position mat on cover board and attach with double-sided tape.
11. Decorate cover.
12. Align backing board, pages and cover. Run selected binding cord through holes, from back to front, so that two long pieces extend from two holes in the front cover. Tie loosely.
13. Decorate pages, then readjust and tie cords into an attractive bow, or tasseled knot. Trim ends.

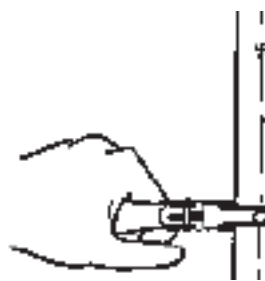

*Using an office style paper punch to punch the holes in the edge of the board.
Use the same punch to punch holes in the paper pages.*

FABRIC-COVERED MATS

WET MOUNTING METHOD

Materials:

11 x 14" mat with opening cut
Mounting paste
Brush
Fabric
Razor blade or hobby knife

1. Cut the opening in the mat first. Apply mounting paste to the front of the matboard.
2. Lay the fabric on the wet paste. Be sure the woven lines are parallel to the edges of the mat.
3. Flip the mat *fabric side down* and slice the fabric in the window area as shown in illustration 3. Be careful of the corners.

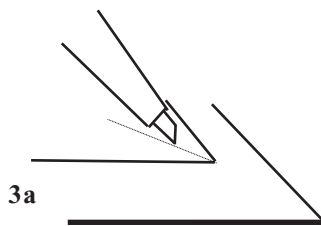
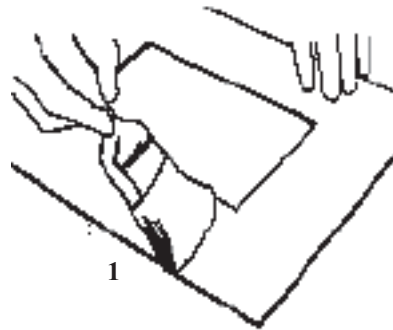

*Be careful of the corners,
do not cut too close.*

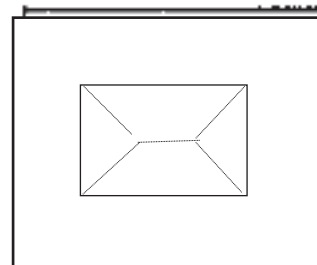

4. Apply the wet mounting paste to the sliced areas. Wrap the four sections to the underside of the mat. Watch for excess paste in the corners—wipe it up right away. A small pointed tool may be useful to get a tight fit.

5. Put the piece under a lite of glass or other weight and allow to dry.

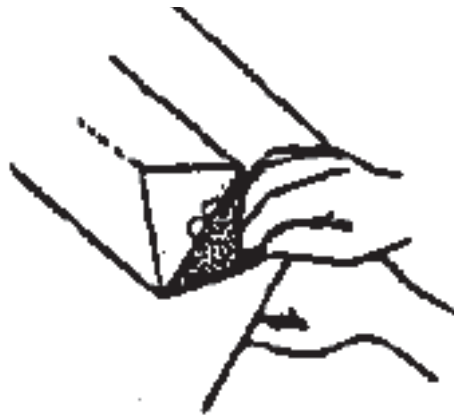

COLD MOUNTING METHOD

Materials:

Pressure-sensitive adhesive sheet
Squeegee or cold mount press
11 x 14" mat with opening cut
Fabric

1. Apply pressure-sensitive adhesive sheet to back side of fabric. Squeegee to bond.
2. Peel cover sheet from pressure-sensitive adhesive and apply fabric to the face of the mat. Line up fabric weave. Squeegee to bond.
3. Place the fabric-covered mat *face down* to cut out a window. Be careful of the corners.
4. Wrap fabric over bevel and secure to back of mat.
5. Use squeegee or cold mount press to create the overall bond.

When working with ovals or circles, the edge that is folded over the mat must be cut in many small places in order to have the fabric wrap over the edge of the matboard without buckling.



1



2



WRAPPING THE BEVEL OF A FABRIC-COVERED BOARD

A matboard with fabric already mounted to it may be cut to have a wrapped edge. The technique follows.

Materials:

11 x 14" fabric-covered board
Double-sided tape or glue

1. Cut a 4" mat border and save the fallout.
2. Adjust blade depth to cut through the matboard only – not the fabric. If the blade cannot be adjusted to a shorter cutting depth, use a hobby knife. Practice on the fallout piece.
3. Put mat back into cutter and cut a 3" border—just through the board, not the fabric.
4. Carefully peel the matboard away from the fabric.
5. Apply double-sided tape to the underside of the matboard on the edge of the window mat.
6. Slice into the corners of the loose fabric with a razor blade or hobby knife.
7. Wrap the loose fabric around the bevel and press onto the exposed tape. Corners may require special attention.

